

⊕ ⊕ A x B

**35906** ø25 200 225 x 70



**35907** ø25 350 375 x 70



**35911** ø30 230 260 x 85



**35909** ø30 300 330 x 85



**35913** ø30 350 380 x 85



**35912** ø30 650 680 x 85



**Deurgrepen:** per stuk.

Bevestigingsmateriaal dient  
afzonderlijk besteld te worden.  
**Zie pagina 116 en 117.**

**Türgriffe:** pro Stück.

Befestigungselementen bitte  
einzeln bestellen.  
**Sehe Seite 116 und 117.**

**Pull handles:** per piece.

Fixing accessories need to be  
ordered separately.  
**See page 116 and 117.**

**Tirants:** par pièce.

Veillez commander les fixations  
séparément.  
**Voir page 116 et 117.a**

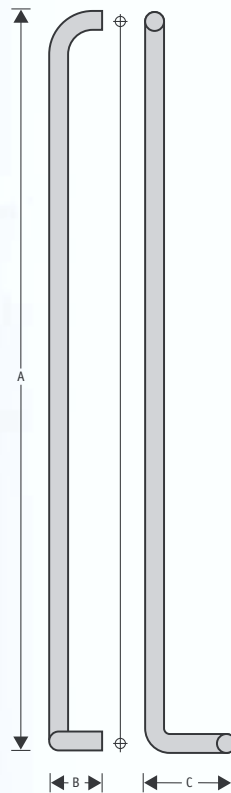
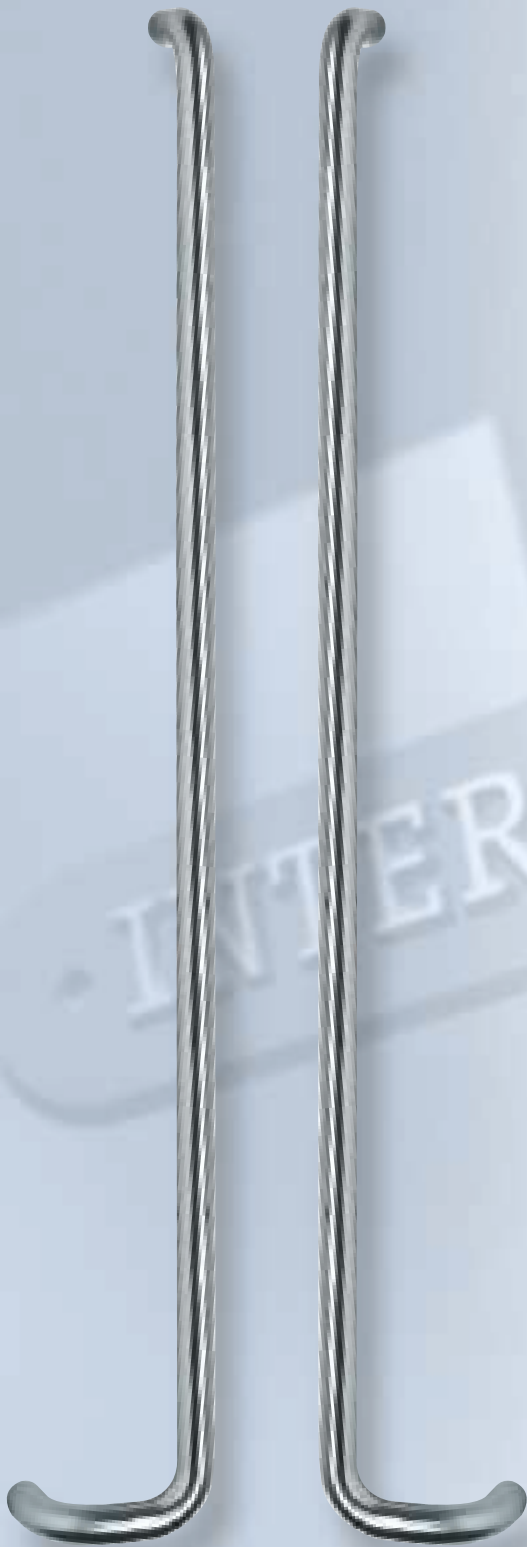

⊕ ⊕ A x B x C

35919L ø25 950 975 x 70 x 120



35919R ø25 950 975 x 70 x 120



**Deurgrepen:** per stuk.

Bevestigingsmateriaal dient afzonderlijk besteld te worden.  
Zie pagina 116 en 117.

**Türgriffe:** pro Stück.

Befestigungselementen bitte einzeln bestellen.  
Sehe Seite 116 und 117.

**Pull handles:** per piece.

Fixing accessories need to be ordered separately.  
See page 116 and 117.

**Tirants:** par pièce.

Veillez commander les fixations séparément.  
Voir page 116 et 117.

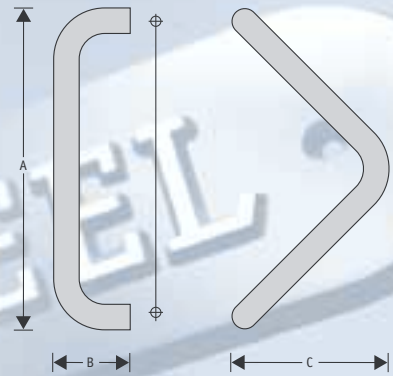

⊕⊕ A x B x C

35915     $\emptyset$ 30 350 380 x 85 x 185    8 714186 046531

**Deurgrepen:** per stuk.

Bevestigingsmateriaal dient  
afzonderlijk besteld te worden.  
**Zie pagina 116 en 117.**

**Türgriffe:** pro Stück.

Befestigungselementen bitte  
einzeln bestellen.  
**Sehe Seite 116 und 117.**

**Pull handles:** per piece.



Fixing accessories need to be  
ordered separately.  
**See page 116 and 117.**

**Tirants:** par pièce.

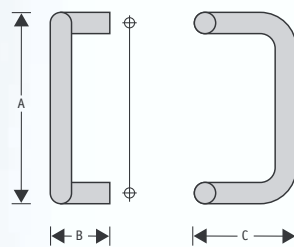
Veuillez commander les fixations  
séparément.  
**Voir page 116 et 117.**



⊕ ⊕ A x B x C

<b>35901</b>	∅25	200	225 x 70 x 120	8	
<b>35904</b>	∅25	350	375 x 70 x 120	8	
<b>35903</b>	∅30	230	260 x 85 x 145	8	

**Deurgrepen:** per stuk.

Bevestigingsmateriaal dient afzonderlijk besteld te worden.  
**Zie pagina 116 en 117.**

**Türgriffe:** pro Stück.

Befestigungselementen bitte einzeln bestellen.  
**Sehe Seite 116 und 117.**

**Pull handles:** per piece.

Fixing accessories need to be ordered separately.  
**See page 116 and 117.**

**Tirants:** par pièce.

Veillez commander les fixations séparément.  
**Voir page 116 et 117.**

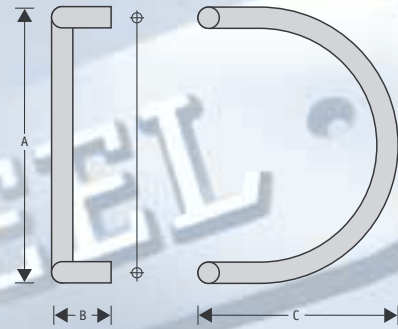

⊕⊕ A x B x C

35920     $\emptyset$ 25 300 325 x 70 x 230    8 714186 054628



**Deurgrepen:** per stuk.

Bevestigingsmateriaal dient  
afzonderlijk besteld te worden.  
**Zie pagina 116 en 117.**

**Türgriffe:** pro Stück.

Befestigungselementen bitte  
einzeln bestellen.  
**Sehe Seite 116 und 117.**

**Pull handles:** per piece.

Fixing accessories need to be  
ordered separately.  
**See page 116 and 117.**

**Tirants:** par pièce.

Veuillez commander les fixations  
séparément.  
**Voir page 116 et 117.**

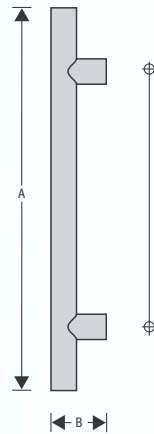

⊕ ⊕ A x B

35914 ø30 300 450 x 65



**Deurgrepen:** per stuk.

Bevestigingsmateriaal dient afzonderlijk besteld te worden.  
**Zie pagina 116 en 117.**

Zie voor constructie-en prijsalternatief pagina 119.

**Türgriffe:** pro Stück.

Befestigungselementen bitte einzeln bestellen.  
**Sehe Seite 116 und 117.**

Für Konstruktions und Preis Alternativ sehen Sie bitte Seite 119.

**Pull handles:** per piece.

Fixing accessories need to be ordered separately.  
**See page 116 and 117.**

See for economic alternative page 119.

**Tirants:** par pièce.

Veillez commander les fixations séparément.  
**Voir page 116 et 117.**

Voir page 119 pour une alternative économique.

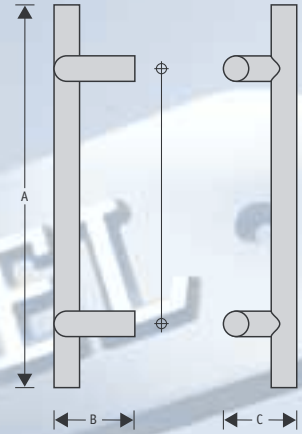

⊕⊕ A x B x C

35970 ø30 300 450 x 85 x 95



**Deurgrepen:** per stuk.

Bevestigingsmateriaal dient  
afzonderlijk besteld te worden.  
Zie pagina 116 en 117.

**Türgriffe:** pro Stück.

Befestigungselementen bitte  
einzeln bestellen.  
Sehe Seite 116 und 117.

**Pull handles:** per piece.

Fixing accessories need to be  
ordered separately.  
See page 116 and 117.

**Tirants:** par pièce.

Veillez commander les fixations  
séparément.  
Voir page 116 et 117.

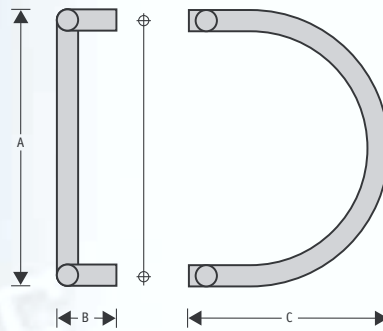

⊕ ⊕ A x B x C

35921 ø25 300 325 x 60 x 180



35922 ø30 300 330 x 65 x 180



**Deurgrepen:** per stuk.

Bevestigingsmateriaal dient afzonderlijk besteld te worden.  
**Zie pagina 116 en 117.**

**Türgriffe:** pro Stück.

Befestigungselementen bitte einzeln bestellen.  
**Sehe Seite 116 und 117.**

**Pull handles:** per piece.

Fixing accessories need to be ordered separately.  
**See page 116 and 117.**

**Tirants:** par pièce.

Veillez commander les fixations séparément.  
**Voir page 116 et 117.**



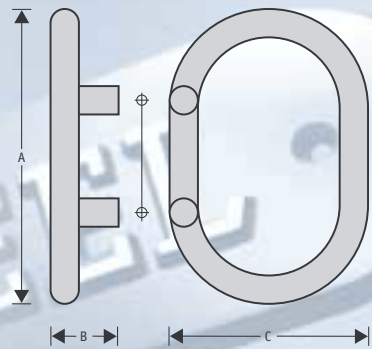

⊕ ⊕ A x B x C

35916     $\varnothing 25$  100 260 x 60 x 150    8 714186 054581

**Deurgrepen:** per stuk.

Bevestigingsmateriaal dient  
afzonderlijk besteld te worden.  
Zie pagina 116 en 117.

**Türgriffe:** pro Stück.

Befestigungselementen bitte  
einzeln bestellen.  
Sehe Seite 116 und 117.

**Pull handles:** per piece.

Fixing accessories need to be  
ordered separately.  
See page 116 and 117.

**Tirants:** par pièce.

Veillez commander les fixations  
séparément.  
Voir page 116 et 117.

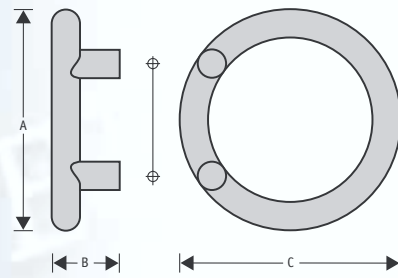

⊕ ⊕ A x B x C

35918     $\varnothing$ 25 100 195 x 60 x 195    8  714186 054604

**Deurgrepen:** per stuk.

Bevestigingsmateriaal dient  
afzonderlijk besteld te worden.  
**Zie pagina 116 en 117.**

**Türgriffe:** pro Stück.

Befestigungselementen bitte  
einzeln bestellen.  
**Sehe Seite 116 und 117.**

**Pull handles:** per piece.

Fixing accessories need to be  
ordered separately.  
**See page 116 and 117.**

**Tirants:** par pièce.

Veillez commander les fixations  
séparément.  
**Voir page 116 et 117.**

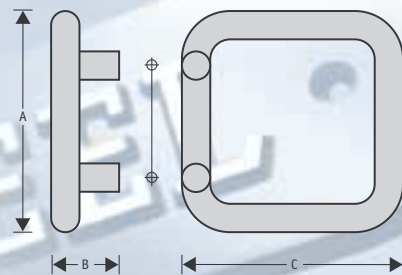

⊕⊕ A x B x C

35917    ø25 100 195 x 60 x 195    8 714186 054598

**Deurgrepen:** per stuk.

Bevestigingsmateriaal dient  
afzonderlijk besteld te worden.  
**Zie pagina 116 en 117.**

**Türgriffe:** pro Stück.

Befestigungselementen bitte  
einzeln bestellen.  
**Sehe Seite 116 und 117.**

**Pull handles:** per piece.

Fixing accessories need to be  
ordered separately.  
**See page 116 and 117.**

**Tirants:** par pièce.

Veillez commander les fixations  
séparément.  
**Voir page 116 et 117.**

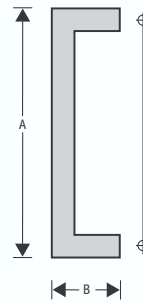

⊕ ⊕ A x B

35975    ø20 200 220 x 60



35976    ø25 300 325 x 65



35977    ø30 350 380 x 70



**Deurgrepen:** per stuk.

Bevestigingsmateriaal dient  
afzonderlijk besteld te worden.  
**Zie pagina 116 en 117.**

**Türgriffe:** pro Stück.

Befestigungselementen bitte  
einzeln bestellen.  
**Sehe Seite 116 en 117.**

**Pull handles:** per piece.

Fixing accessories need to be  
ordered separately.  
**See page 116 and 117.**

**Tirants:** par pièce.

Veillez commander les fixations  
séparément.  
**Voir page 116 et 117.**

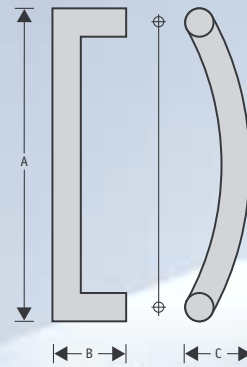

⊕ ⊕ A x B x C

**35965**     $\emptyset 25$  250 275 x 65 x 60    8 714186 056325

**35966**     $\emptyset 30$  300 330 x 70 x 70    8 714186 057094

**35967**     $\emptyset 35$  700 735 x 75 x 125    8 714186 056356

**Deurgrepen:** per stuk.

Bevestigingsmateriaal dient  
afzonderlijk besteld te worden.  
**Zie pagina 116 en 117.**

**Türgriffe:** pro Stück.

Befestigungselementen bitte  
einzeln bestellen.  
**Sehe Seite 116 und 117.**

**Pull handles:** per piece.

Fixing accessories need to be  
ordered separately.  
**See page 116 and 117.**

**Tirants:** par pièce.

Veuillez commander les fixations  
séparément.  
**Voir page 116 et 117.**

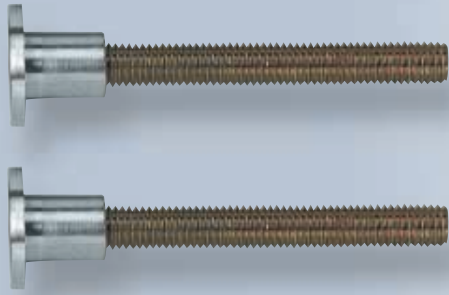

<b>35951</b>	75mm	1 zijde; ø-universeel	Einseitig; ø-universal	single; ø-universal	sur une face; ø-universel
<b>35951a</b>	110mm	1 zijde; ø-universeel	Einseitig; ø-universal	single; ø-universal	sur une face; ø-universel

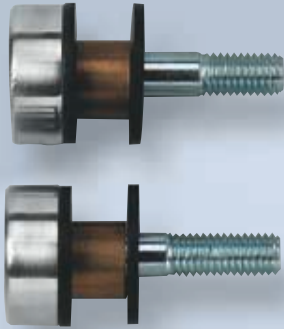

<b>35949</b>	1 zijde op glas; ø20	Einseitig an Glas; ø20	single to glass; ø20	sur une face sur verre; ø20
<b>35943</b>	1 zijde op glas; ø25	Einseitig an Glas; ø25	single to glass; ø25	sur une face sur verre; ø25
<b>35946</b>	1 zijde op glas; ø30	Einseitig an Glas; ø30	single to glass; ø30	sur une face sur verre; ø30
<b>35948</b>	1 zijde op glas; ø35	Einseitig an Glas; ø35	single to glass; ø35	sur une face sur verre; ø35

**Bevestigingsmateriaal.**  
Doorgaande bevestiging.

**Befestigungselementen.**  
Durchgehende Befestigung.

**Fixing accessories.**  
Through assembly.

**Fixation.**  
Fixation traversante.



<b>35955</b>	1 zijde; ø20	Einseitig; ø20	single; ø20	sur une face; ø20
<b>35952</b>	1 zijde; ø25	Einseitig; ø25	single; ø25	sur une face; ø25
<b>35953</b>	1 zijde; ø30	Einseitig; ø30	single; ø30	sur une face; ø30
<b>35954</b>	1 zijde; ø35	Einseitig; ø35	single; ø35	sur une face; ø35.

**Bevestigingsmateriaal.**  
Opschroevende bevestiging.  
Voor 1 deurgreep.  
Niet geschikt voor glas.

**Befestigungselementen.**  
Befestigung zum Aufschrauben.  
Geeignet für 1 Türgriff.  
Nicht geeignet für Glastüren.

**Fixing accessories.**  
Face fixing assembly  
not suitable for glass doors.

**Fixation.**  
Fixation sur rosace sur une  
face pour un tirant.  
Pas pour les portes en verre.

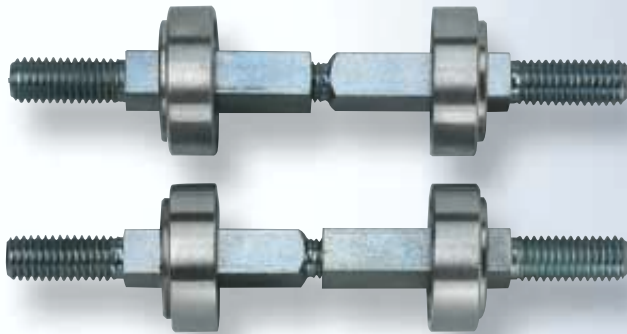

35929  
35931  
35934  
35928

2-zijdig;  $\varnothing 20$   
2-zijdig;  $\varnothing 25$   
2-zijdig;  $\varnothing 30$   
2-zijdig;  $\varnothing 35$

Paarweise;  $\varnothing 20$   
Paarweise;  $\varnothing 25$   
Paarweise;  $\varnothing 30$   
Paarweise;  $\varnothing 35$

double;  $\varnothing 20$   
double;  $\varnothing 25$   
double;  $\varnothing 30$   
double;  $\varnothing 35$

par paire;  $\varnothing 20$   
par paire;  $\varnothing 25$   
par paire;  $\varnothing 30$   
par paire;  $\varnothing 35$

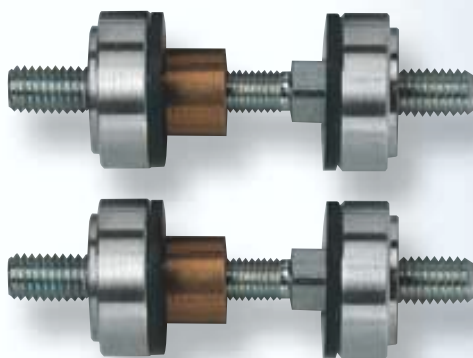

35935  
35937  
35940  
35941

2-zijdig op glas;  $\varnothing 20$   
2-zijdig op glas;  $\varnothing 25$   
2-zijdig op glas;  $\varnothing 30$   
2-zijdig op glas;  $\varnothing 35$

Paarweise an Glas;  $\varnothing 20$   
Paarweise an Glas;  $\varnothing 25$   
Paarweise an Glas;  $\varnothing 30$   
Paarweise an Glas;  $\varnothing 35$

double to glass;  $\varnothing 20$   
double to glass;  $\varnothing 25$   
double to glass;  $\varnothing 30$   
double to glass;  $\varnothing 35$

par paire sur verre;  $\varnothing 20$   
par paire sur verre;  $\varnothing 25$   
par paire sur verre;  $\varnothing 30$   
par paire sur verre;  $\varnothing 35$

**Bevestigingsmateriaal.**  
Doorgaande bevestiging.

**Befestigungselementen.**  
Durchgehende Befestigung.

**Fixing accessories.**  
Through assembly.

**Fixation.**  
Fixation traversante.



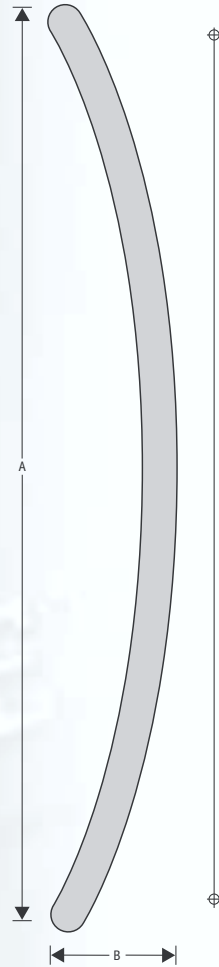

⊕ ⊕ A x B

**35978** ø30 500 605 x 70



8 714186 078617

**35979** ø30 700 850 x 70



8 714186 078624

**Deurgrepen:** per stuk.

**Uitsluitend te bestellen met onderstaande doorgaande bevestiging.**

**35956** 1 zijde; universeel  
**35956a** 1 zijde op glas tbv 35978  
**35956b** 1 zijde op glas tbv 35979

**35957** 2-zijdig; universeel  
**35957a** 2-zijdig op glas tbv 35978  
**35957b** 2-zijdig op glas tbv 35979

**Türgriffe:** pro Stück.

**Nur mit untenstehende durchgehende Befestigungselementen.**

Einseitig; universal  
 Einseitig an Glas für 35978  
 Einseitig an Glas für 35979

Paarweise; universal  
 Paarweise an Glas für 35978  
 Paarweise an Glas für 35979

**Pull handles:** per piece.

**To order only with fixing accessories as shown below. Through assembly.**

single; universal  
 single to glass for 35978  
 single to glass for 35979

double; universal  
 double to glass for 35978  
 double to glass for 35979

**Tirants:** par pièce.

**A commander seulement avec les fixations traversantes ci-dessous.**

sur une face; universel  
 sur une face sur verre 35978  
 sur une face sur verre 35979

par paire; universel  
 par paire sur verre 35978  
 par paire sur verre 35979



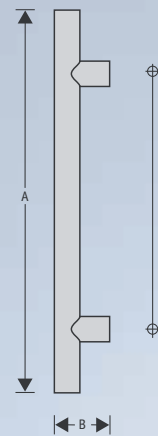

⊕ ⊕ A x B

**35980**     $\varnothing 20$  200 350 x 65



**35981**     $\varnothing 25$  250 400 x 70



**35982**     $\varnothing 25$  350 500 x 70



**35983**     $\varnothing 30$  300 450 x 75



**35984**     $\varnothing 30$  350 500 x 75



**35985**     $\varnothing 35$  350 520 x 80



**35986**     $\varnothing 35$  500 650 x 80



**Deurgrepen:** per stuk.

**Türgriffe:** pro Stück.

**Pull handles:** per piece.

**Tirants:** par pièce.

**Uitsluitend te bestellen met onderstaande doorgaande bevestiging.**

**Nur mit untenstehender durchgehenden Befestigungselementen.**

**To order only with fixing accessories as shown below. Through assembly.**

**A commander seulement avec les fixations traversantes ci-dessous.**

**35958**    1 zijde; universeel  
**35958a**    1 zijde op glas tbv  $\varnothing 20$   
**35958b**    1 zijde op glas tbv  $\varnothing 25$   
**35958c**    1 zijde op glas tbv  $\varnothing 30$   
**35958d**    1 zijde op glas tbv  $\varnothing 35$

Einseitig; universal  
 Einseitig an Glas für  $\varnothing 20$   
 Einseitig an Glas für  $\varnothing 25$   
 Einseitig an Glas für  $\varnothing 30$   
 Einseitig an Glas für  $\varnothing 35$

single; universal  
 single to glass for  $\varnothing 20$   
 single to glass for  $\varnothing 25$   
 single to glass for  $\varnothing 30$   
 single to glass for  $\varnothing 35$

sur une face; universel  
 sur une face sur verre  $\varnothing 20$   
 sur une face sur verre  $\varnothing 25$   
 sur une face sur verre  $\varnothing 30$   
 sur une face sur verre  $\varnothing 35$

**35959**    2-zijdig; universeel  
**35959a**    2-zijdig op glas universeel

Paarweise; universal  
 Paarweise an Glas universal

double; universal  
 double to glass universal

par paire; universel  
 par paire sur verre universal